

### Hyperfast Rectifier

#### Features

- Hyperfast Recovery Time
- Low Forward Voltage Drop
- Low Leakage Current
- 175°C Operating Junction Temperature
- Single Diode Center Tap

$$t_{rr} = 28\text{ns typ.}$$

$$I_{F(AV)} = 30\text{Amp}$$

$$V_R = 600\text{V}$$

#### Description/ Applications

State of the art Hyperfast recovery rectifiers designed with optimized performance of forward voltage drop, Hyperfast recover time, and soft recovery.

The planar structure and the platinum doped life time control guarantee the best overall performance, ruggedness and reliability characteristics.

These devices are intended for use in PFC Boost stage in the AC-DC section of SMPS, inverters or as freewheeling diodes.

The IR extremely optimized stored charge and low recovery current minimize the switching losses and reduce over dissipation in the switching element and snubbers.

#### Absolute Maximum Ratings

Parameters	Max	Units
$V_{RRM}$ Peak Repetitive Reverse Voltage	600	V
$I_{F(AV)}$ Average Rectifier Forward Current @ $T_C = 116^\circ\text{C}$	30	A
$I_{FSM}$ Non Repetitive Peak Surge Current @ $T_J = 25^\circ\text{C}$	300	
$T_J, T_{STG}$ Operating Junction and Storage Temperatures	- 65 to 175	$^\circ\text{C}$

#### Case Styles

30EPH06



TO247

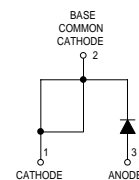

**Electrical Characteristics @ T<sub>J</sub> = 25°C (unless otherwise specified)**

Parameters	Min	Typ	Max	Units	Test Conditions
V <sub>BR</sub> , V <sub>F</sub> Breakdown Voltage, Blocking Voltage	600	-	-	V	I <sub>R</sub> = 100μA
V <sub>F</sub> Forward Voltage	-	2.0	2.6	V	I <sub>F</sub> = 30A, T <sub>J</sub> = 25°C
	-	1.34	1.75	V	I <sub>F</sub> = 30A, T <sub>J</sub> = 150°C
I <sub>R</sub> Reverse Leakage Current	-	0.3	50	μA	V <sub>R</sub> = V <sub>R</sub> Rated
	-	60	500	μA	T <sub>J</sub> = 150°C, V <sub>R</sub> = V <sub>R</sub> Rated
C <sub>T</sub> Junction Capacitance	-	33	-	pF	V <sub>R</sub> = 600V
L <sub>S</sub> Series Inductance	-	3.5	-	nH	Measured lead to lead 5mm from package body

**Dynamic Recovery Characteristics @ T<sub>J</sub> = 25°C (unless otherwise specified)**

Parameters	Min	Typ	Max	Units	Test Conditions	
t <sub>rr</sub> Reverse Recovery Time	-	28	35	ns	I <sub>F</sub> = 1.0A, di <sub>F</sub> /dt = 50A/μs, V <sub>R</sub> = 30V	
	-	31	-		T <sub>J</sub> = 25°C	I <sub>F</sub> = 30A V <sub>R</sub> = 200V di <sub>F</sub> /dt = 200A/μs
	-	77	-		T <sub>J</sub> = 125°C	
I <sub>RRM</sub> Peak Recovery Current	-	3.5	-	A	T <sub>J</sub> = 25°C	
	-	7.7	-	A	T <sub>J</sub> = 125°C	
Q <sub>rr</sub> Reverse Recovery Charge	-	65	-	nC	T <sub>J</sub> = 25°C	
	-	345	-		T <sub>J</sub> = 125°C	

**Thermal - Mechanical Characteristics**

Parameters	Min	Typ	Max	Units
T <sub>J</sub> Max. Junction Temperature Range	- 65	-	175	°C
T <sub>Stg</sub> Max. Storage Temperature Range	- 65	-	175	
R <sub>thJC</sub> Thermal Resistance, Junction to Case Per Leg	-	0.5	0.9	°C/W
R <sub>thJA</sub> <sup>①</sup> Thermal Resistance, Junction to Ambient Per Leg	-	-	70	
R <sub>thCS</sub> <sup>②</sup> Thermal Resistance, Case to Heatsink	-	0.4	-	
Wt Weight	-	6.0	-	g
	-	0.22	-	(oz)
Mounting Torque	6.0	-	12	Kg-cm
	5.0	-	10	lbf.in

① Typical Socket Mount

② Mounting Surface, Flat, Smooth and Greased

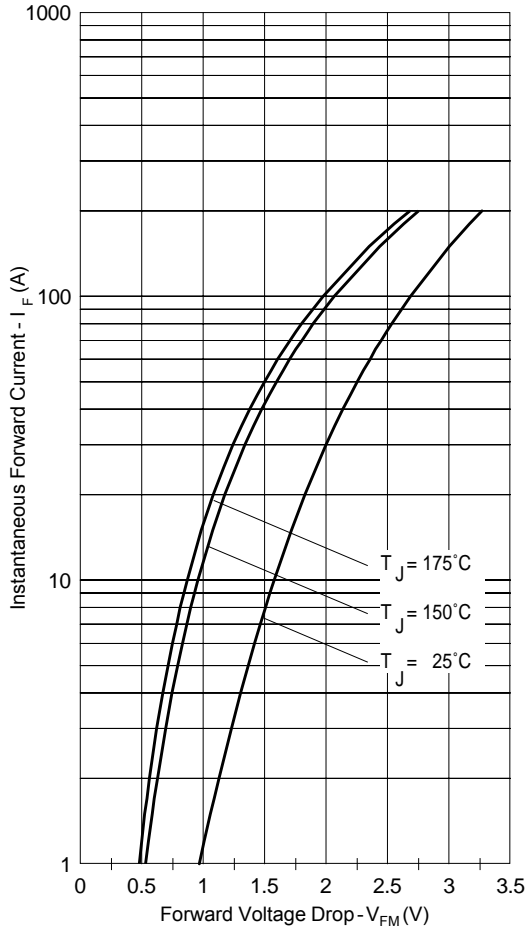

Fig. 1 - Typical Forward Voltage Drop Characteristics

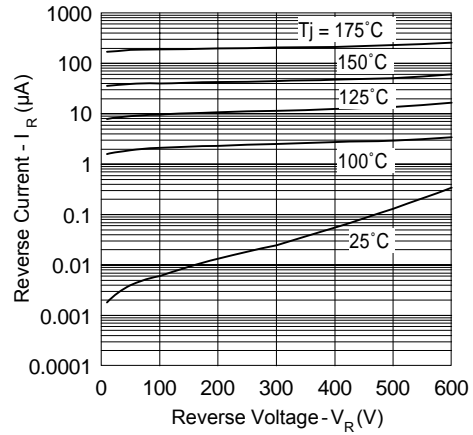

Fig. 2 - Typical Values Of Reverse Current Vs. Reverse Voltage

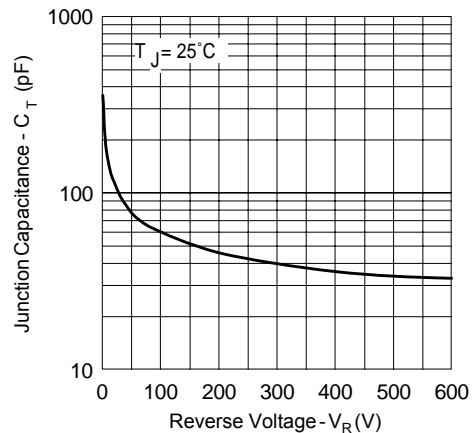

Fig. 3 - Typical Junction Capacitance Vs. Reverse Voltage

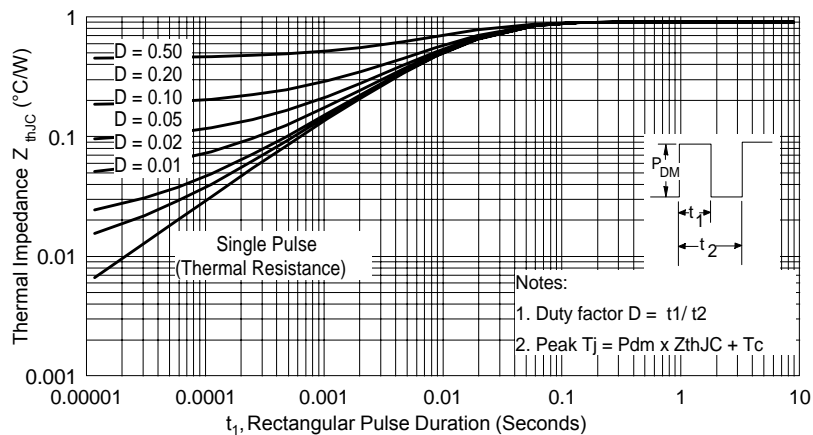
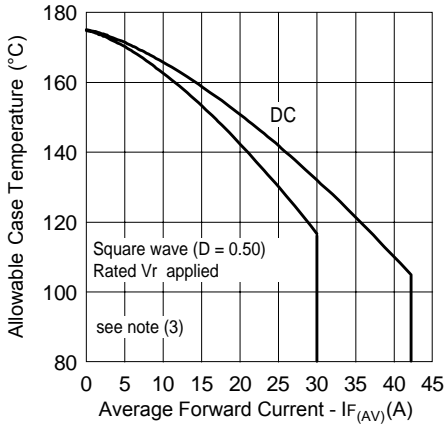
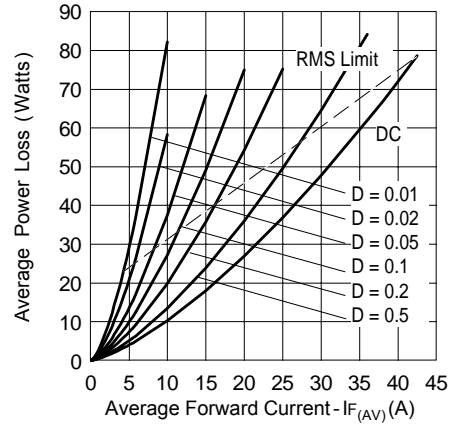

Fig. 4 - Max. Thermal Impedance  $Z_{thJC}$  Characteristics



**Fig. 5 - Max. Allowable Case Temperature Vs. Average Forward Current**



**Fig. 6 - Forward Power Loss Characteristics**

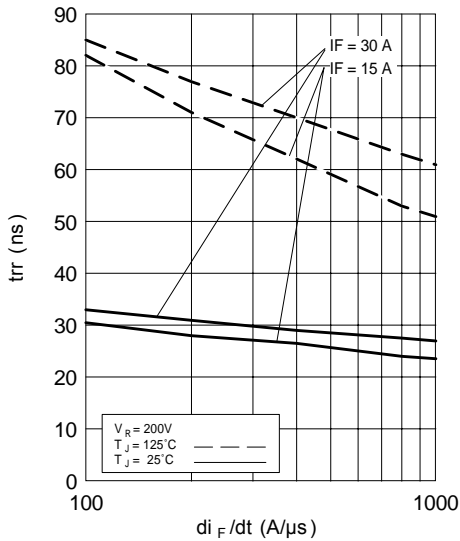

**Fig. 7 - Typical Reverse Recovery vs. di\_F/dt**

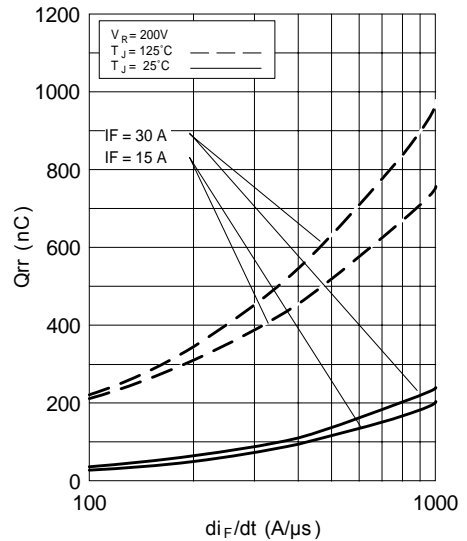

**Fig. 8 - Typical Stored Charge vs. di\_F/dt**

(3) Formula used:  $T_c = T_j - (Pd + Pd_{REV}) \times R_{thJC}$ ;  
 $Pd = \text{Forward Power Loss} = I_{F(AV)} \times V_{FM} @ (I_{F(AV)} / D)$  (see Fig. 6);  
 $Pd_{REV} = \text{Inverse Power Loss} = V_{R1} \times I_R (1 - D); I_R @ V_{R1} = \text{rated } V_R$

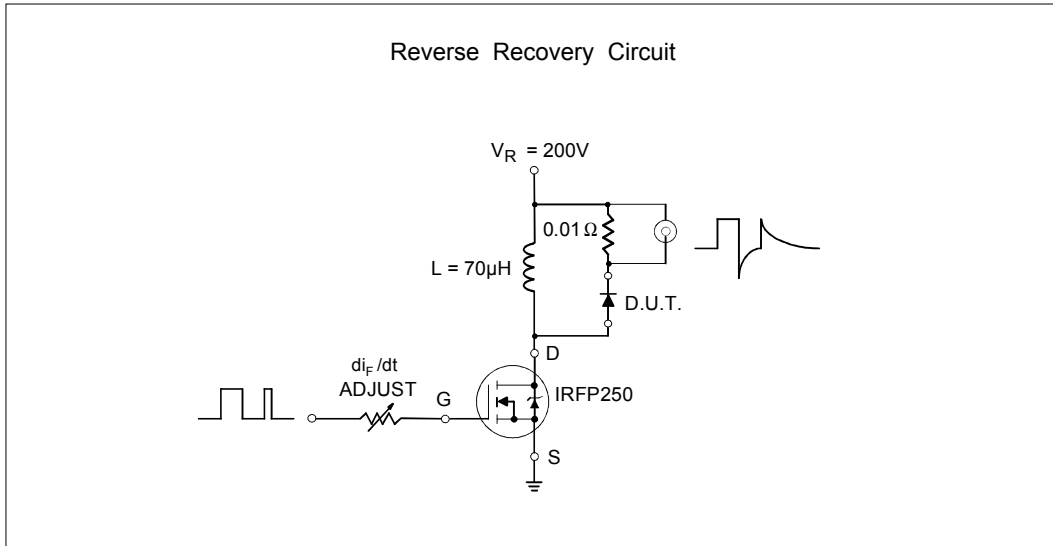

Fig. 9- Reverse Recovery Parameter Test Circuit

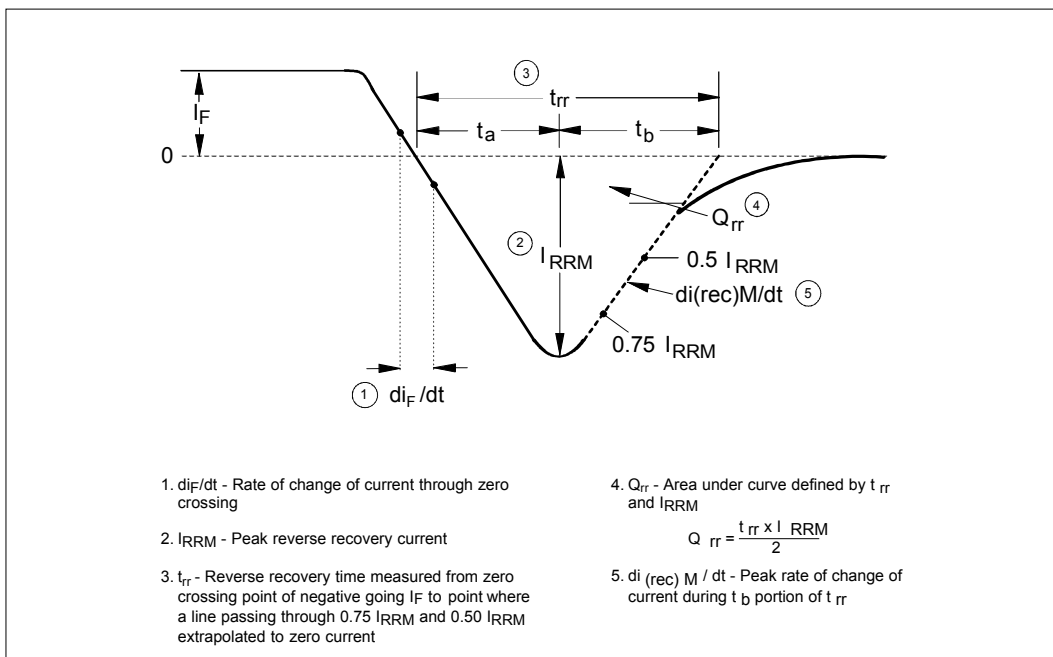
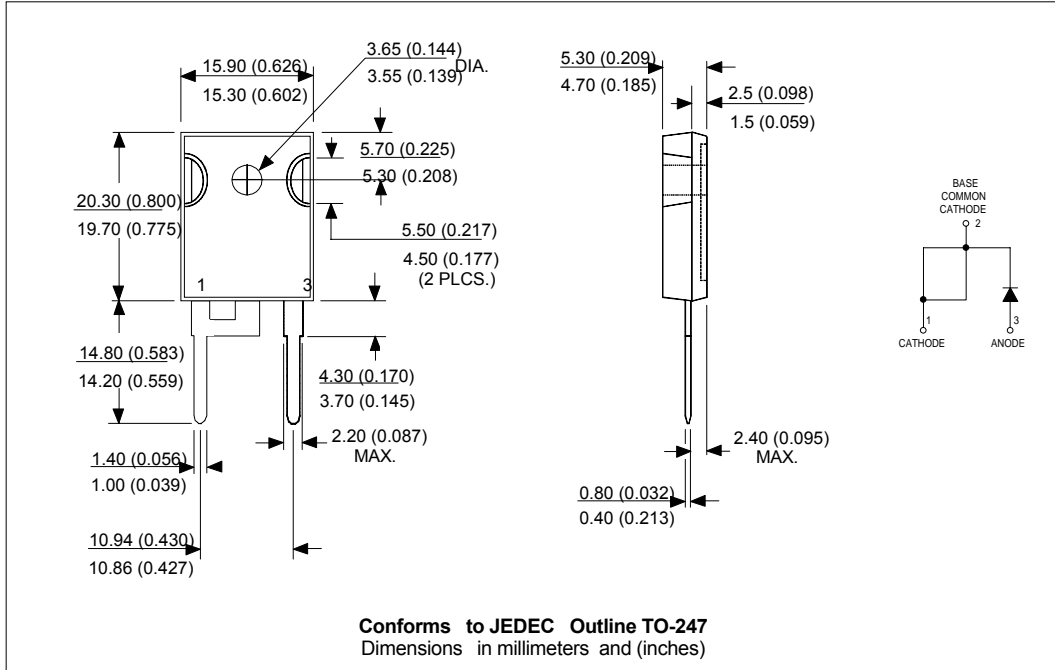
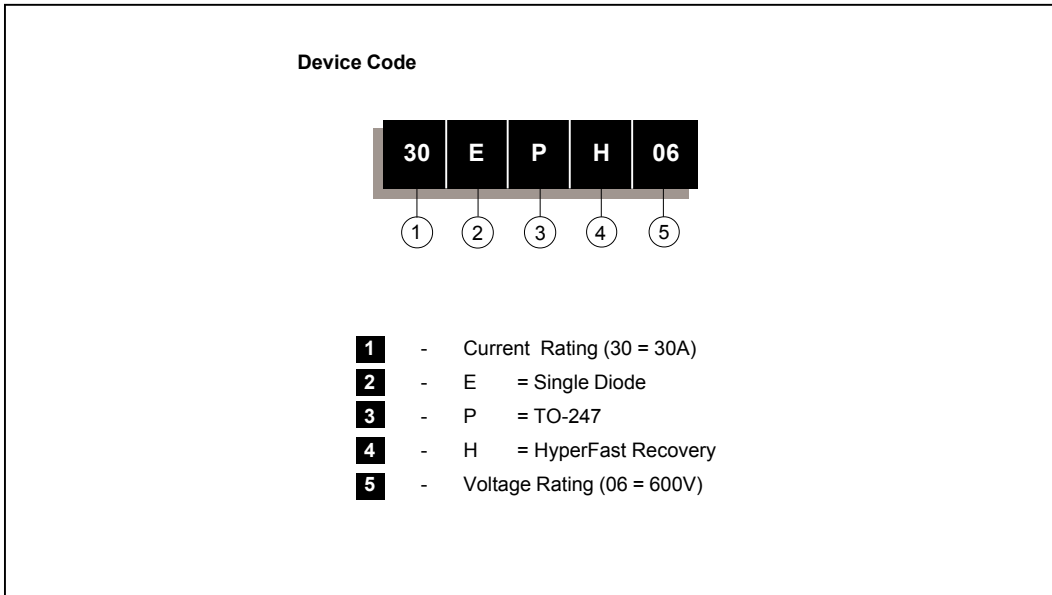

Fig. 10 - Reverse Recovery Waveform and Definitions

Outline Table



Ordering Information Table



Data and specifications subject to change without notice.  
This product has been designed and qualified for Industrial Level.  
Qualification Standards can be found on IR's Web site.

International  
**IOR** Rectifier

**IR WORLD HEADQUARTERS:** 233 Kansas St., El Segundo, California 90245, USA Tel: (310) 252-7105  
TAC Fax: (310) 252-7309  
Visit us at [www.irf.com](http://www.irf.com) for sales contact information 08/01