



60EPU06  
60APU06

## Ultrafast Soft Recovery Diode

### Features

- Ultrafast Recovery
- 175°C Operating Junction Temperature

### Benefits

- Reduced RFI and EMI
- Higher Frequency Operation
- Reduced Snubbing
- Reduced Parts Count

$t_{rr} = 34\text{ns (typ)}$
$I_{F(AV)} = 60\text{Amp}$
$V_R = 600\text{V}$

### Description/ Applications


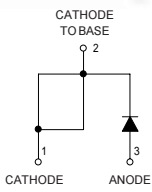

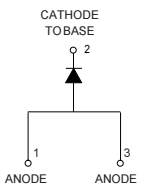
These diodes are optimized to reduce losses and EMI/ RFI in high frequency power conditioning systems. The softness of the recovery eliminates the need for a snubber in most applications. These devices are ideally suited for HF welding, power converters and other applications where switching losses are not significant portion of the total losses.

### Absolute Maximum Ratings

Parameters	Max	Units
$V_R$ Cathode to Anode Voltage	600	V
$I_{F(AV)}$ Continuous Forward Current, $T_C = 116^\circ\text{C}$	60	A
$I_{FSM}$ Single Pulse Forward Current, $T_C = 25^\circ\text{C}$	600	
$I_{FRM}$ ① Maximum Repetitive Forward Current	120	
$T_J, T_{STG}$ Operating Junction and Storage Temperatures	- 55 to 175	$^\circ\text{C}$

① Square Wave, 20kHz

### Case Styles

<p>60EPU06</p>   <p>TO-247AC (Modified)</p>	<p>60APU06</p>   <p>TO-247AC</p>
---	--

**Electrical Characteristics @  $T_J = 25^\circ\text{C}$  (unless otherwise specified)**

Parameters	Min	Typ	Max	Units	Test Conditions
$V_{BR}, V_r$ Breakdown Voltage, Blocking Voltage	600	-	-	V	$I_R = 100\mu\text{A}$
$V_F$ Forward Voltage	-	1.35	1.68	V	$I_F = 60\text{A}$
	-	1.20	1.42	V	$I_F = 60\text{A}, T_J = 125^\circ\text{C}$
	-	1.11	1.30	V	$I_F = 60\text{A}, T_J = 175^\circ\text{C}$
$I_R$ Reverse Leakage Current	-	-	50	$\mu\text{A}$	$V_R = V_R \text{ Rated}$
	-	-	500	$\mu\text{A}$	$T_J = 150^\circ\text{C}, V_R = V_R \text{ Rated}$
$C_T$ Junction Capacitance	-	39	-	pF	$V_R = 600\text{V}$

**Dynamic Recovery Characteristics @  $T_J = 25^\circ\text{C}$  (unless otherwise specified)**

Parameters	Min	Typ	Max	Units	Test Conditions	
$t_{rr}$ Reverse Recovery Time	-	34	45	ns	$I_F = 1\text{A}, di_F/dt = 200\text{A}/\mu\text{s}, V_R = 30\text{V}$  $I_F = 60\text{A}$ $V_R = 200\text{V}$ $di_F/dt = 200\text{A}/\mu\text{s}$	
	-	81	-			$T_J = 25^\circ\text{C}$
	-	164	-			$T_J = 125^\circ\text{C}$
$I_{RRM}$ Peak Recovery Current	-	7.4	-	A	$T_J = 25^\circ\text{C}$	
	-	17.0	-		$T_J = 125^\circ\text{C}$	
$Q_{rr}$ Reverse Recovery Charge	-	300	-	nC	$T_J = 25^\circ\text{C}$	
	-	1394	-		$T_J = 125^\circ\text{C}$	

**Thermal - Mechanical Characteristics**

Parameters	Min	Typ	Max	Units
$R_{thJC}$ Thermal Resistance, Junction to Case			0.63	K/W
$R_{thCS} \text{ ②}$ Thermal Resistance, Case to Heatsink		0.2		
$Wt$ Weight		5.5		g
		0.2		(oz)
$T$ Mounting Torque	1.2		2.4	N * m
	10		20	lbf.in

② Mounting Surface, Flat, Smooth and Greased

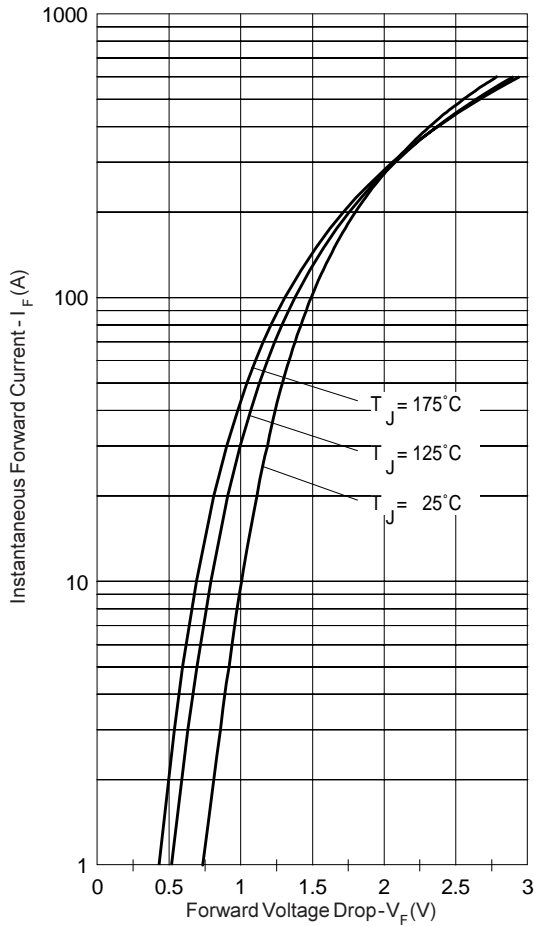


Fig. 1 - Typical Forward Voltage Drop Characteristics

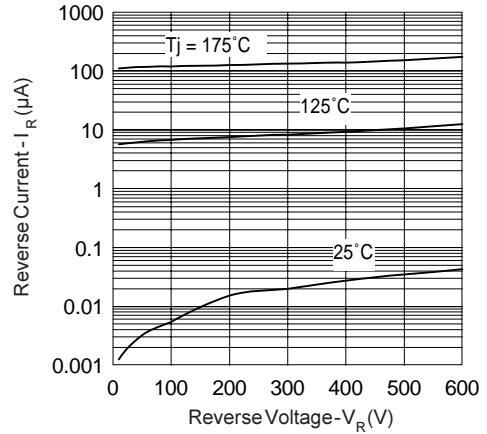


Fig. 2 - Typical Values Of Reverse Current Vs. Reverse Voltage

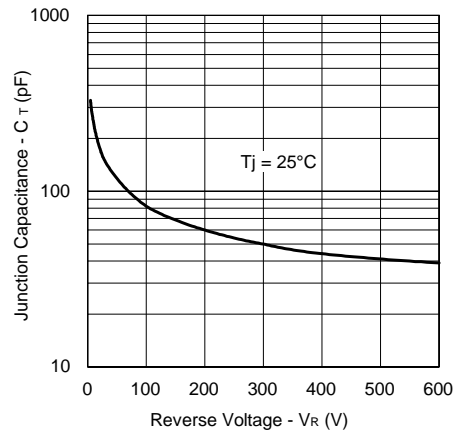


Fig. 3 - Typical Junction Capacitance Vs. Reverse Voltage

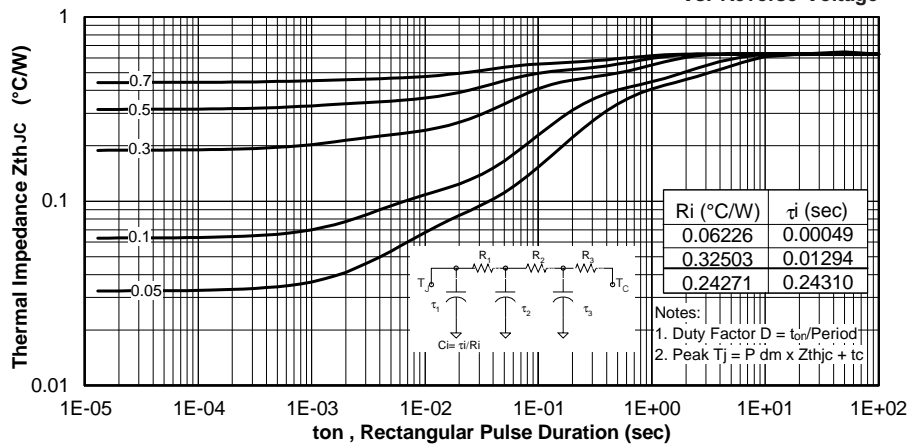
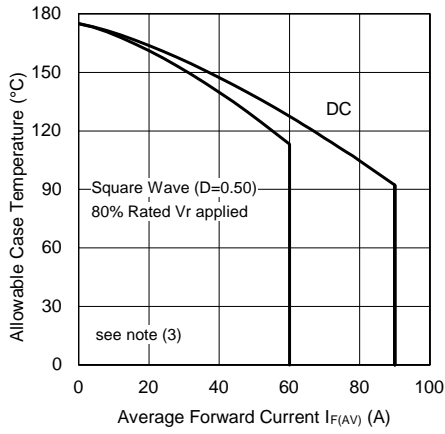
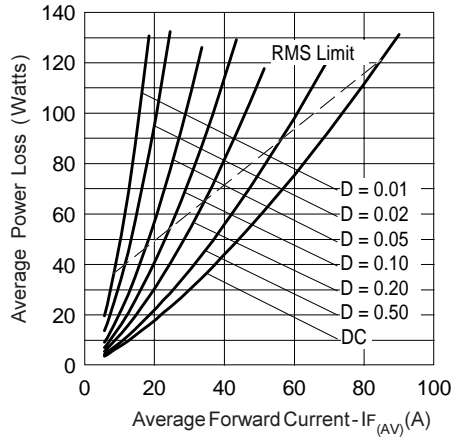


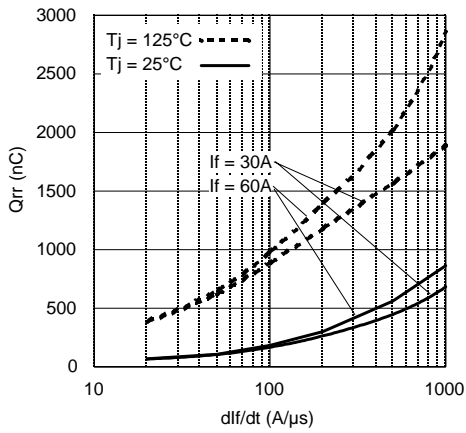
Fig. 4 - Max. Thermal Impedance Z<sub>thJC</sub> Characteristics



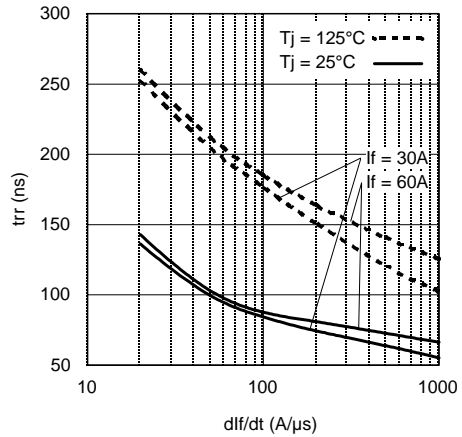
**Fig. 5 - Max. Allowable Case Temperature Vs. Average Forward Current**



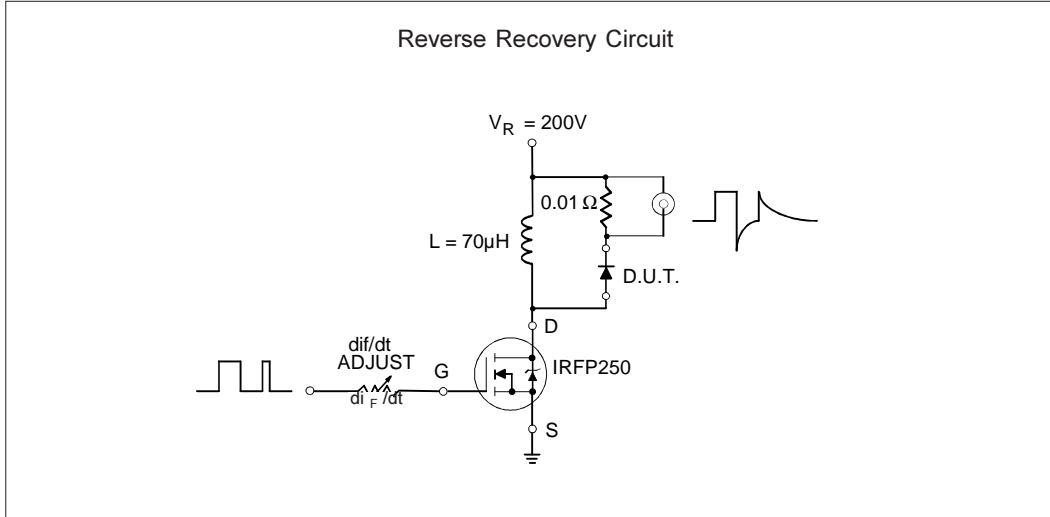
**Fig. 6 - Forward Power Loss Characteristics**



**Fig. 7 - Typical Stored Charge vs. di/dt**

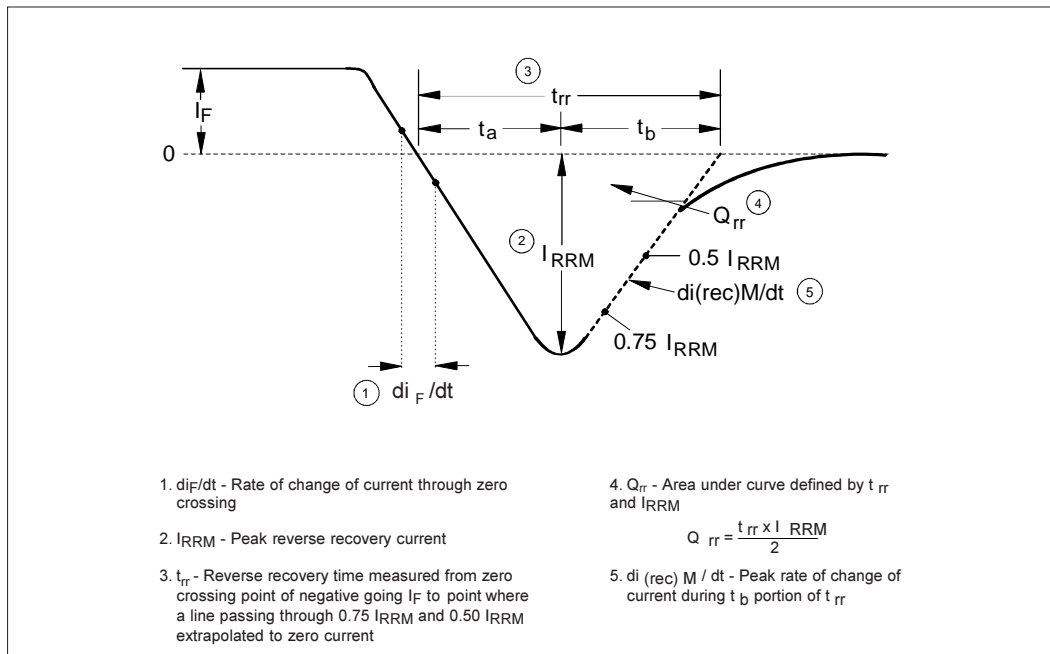


**Fig. 8 - Typical Reverse Recovery Time vs. di/dt**



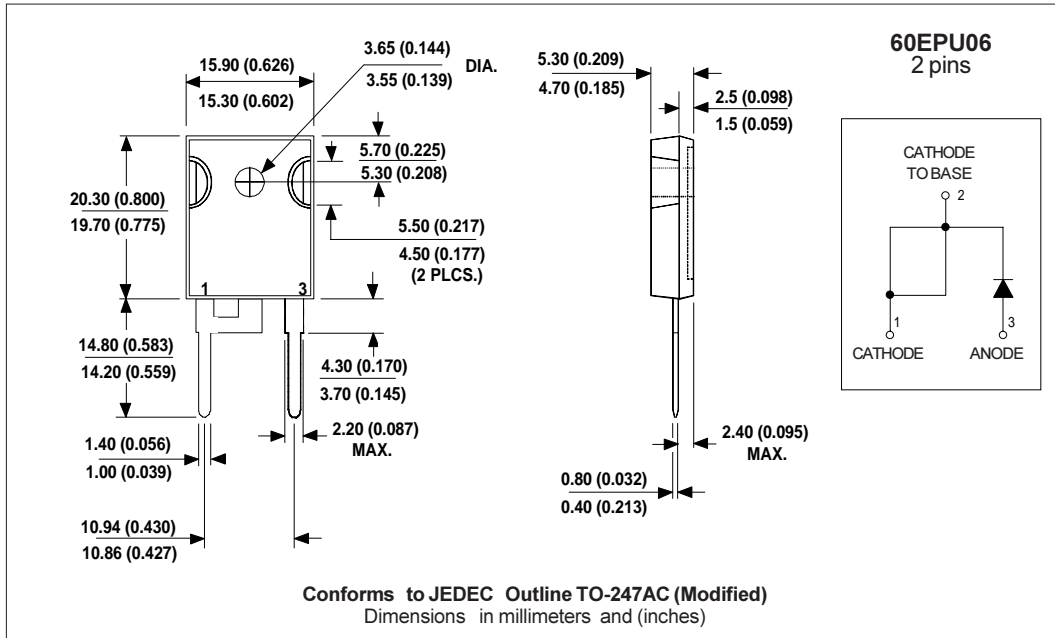
**Fig. 7 - Reverse Recovery Parameter Test Circuit**

- (3) Formula used:  $T_c = T_j - (Pd + Pd_{REV}) \times R_{thJC}$  ;  
 $Pd$  = Forward Power Loss =  $I_{F(AV)} \times V_{FM} @ (I_{F(AV)} / D)$  (see Fig. 6);  
 $Pd_{REV}$  = Inverse Power Loss =  $V_{R1} \times I_R (1 - D)$ ;  $I_R @ V_{R1} = 80\%$  rated  $V_R$

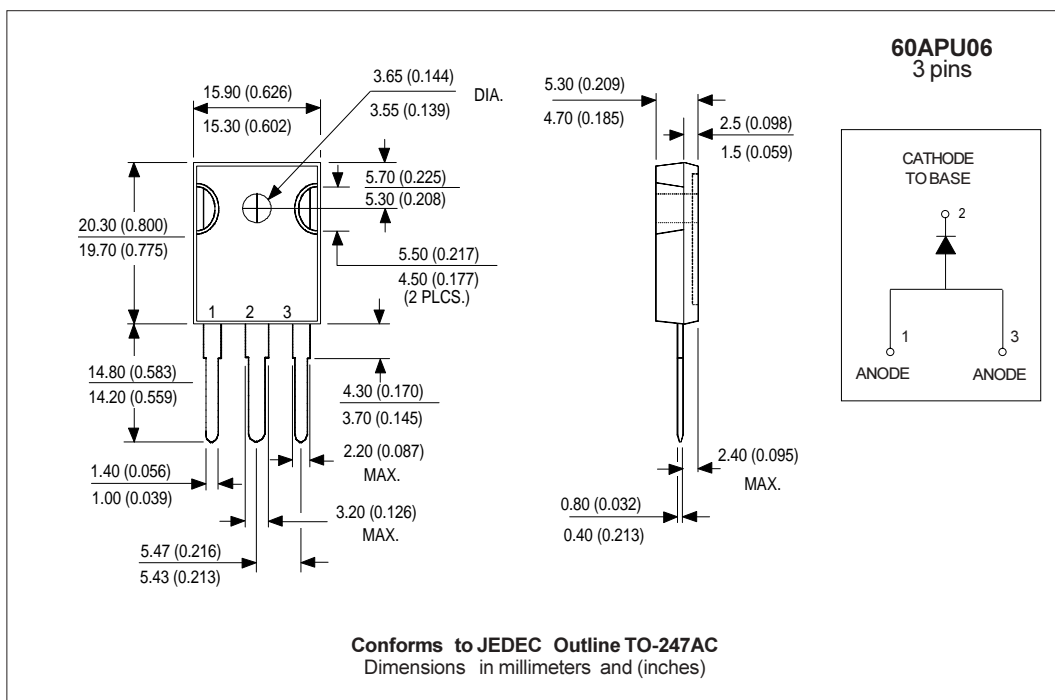


**Fig. 8 - Reverse Recovery Waveform and Definitions**

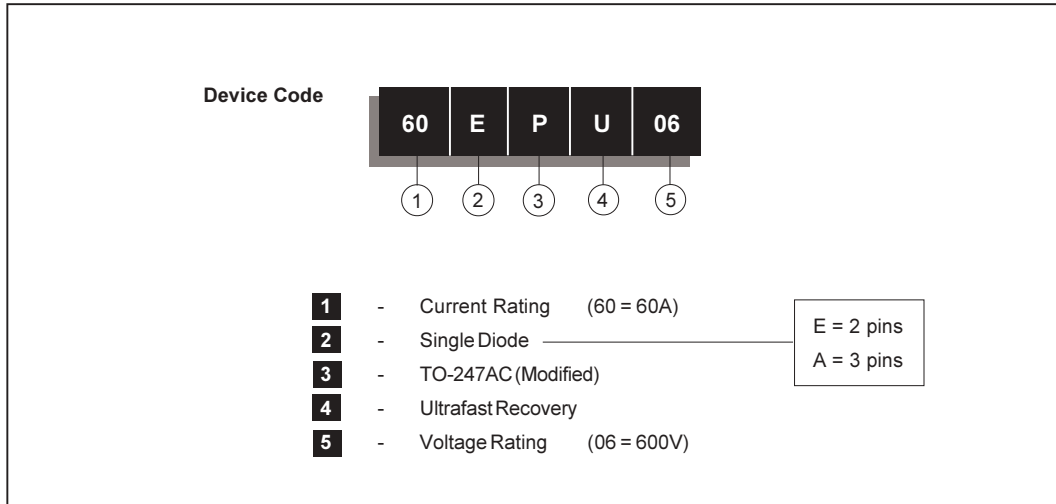
Outline Table



Outline Table



Ordering Information Table



Data and specifications subject to change without notice.  
 This product has been designed and qualified for Industrial Level.  
 Qualification Standards can be found on IR's Web site.